

Premium LED Hallenleuchte 150W

Highlumen 200lm/W

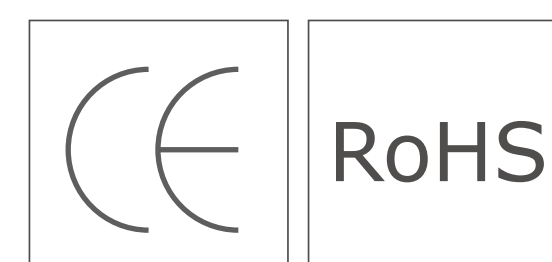

- CREE LED Chips, für beste Lichtausbeute
- Kühlung mittels Kupferkern und Magnesium Kühlkörper
- Verschiedene Schirme optional verfügbar

Modell	150W / 3000K/4000K/5000K
Art. Nr.	PRE-HB-highlumen-150W-COB-3000K/4000K/5000K
Befestigung	Öse für die Aufhängung
LED Chip	CREE
Anschlussleistung	ca. 152Watt
Lichtstrom	27750lm / 29000lm / 30000lm
Lumen pro Watt	185-200lm/W
Farbwiedergabe Ra (CRI)	Ra >70
LED Type u. Anzahl	SMD 2835 536pcs
Material	Hoch effizienter Magnesium Kühlkörper Led Chip auf massivem Träger aus versilbertem Kupfer
Abstrahlwinkel	120° mit Strahlung nach unten (ohne Reflektor)
Spannung; Frequenz	AC100-277V
Technik	optional: DALI oder 1-10V dimmbar



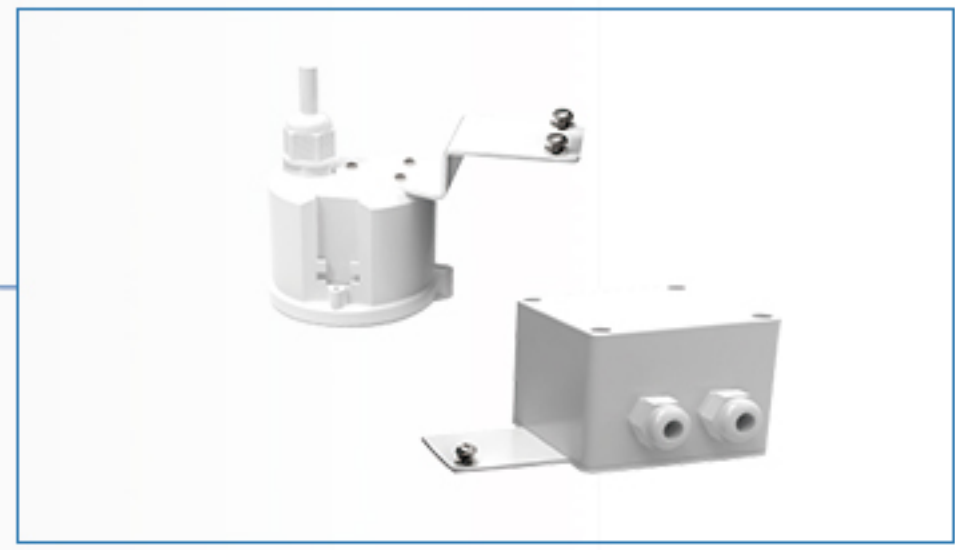
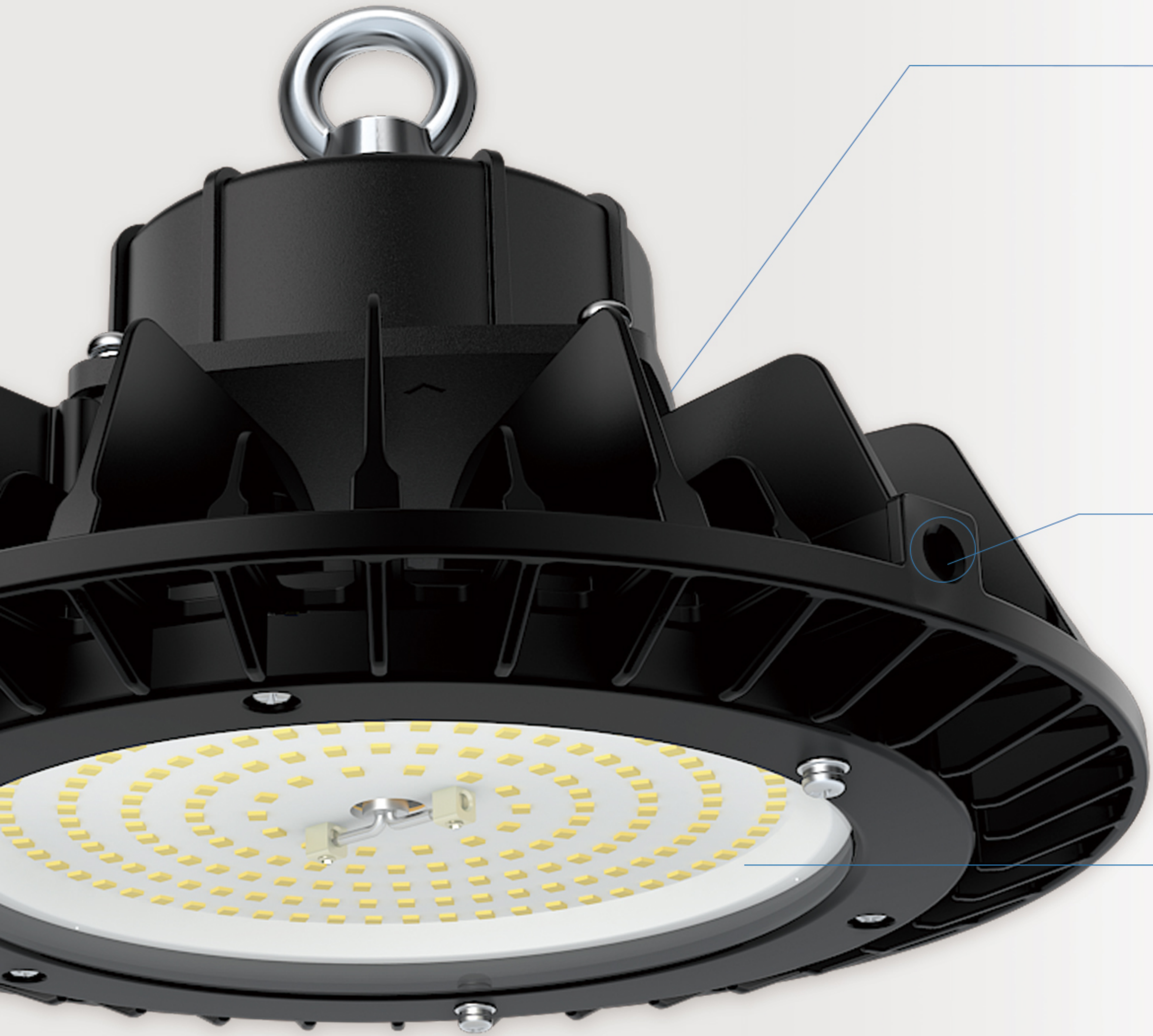

Sensor Kit
PRE-HB-highlumen-150W-COB-SK



verstellbare Halterung
PRE-HB-highlumen-150W-COB-VK

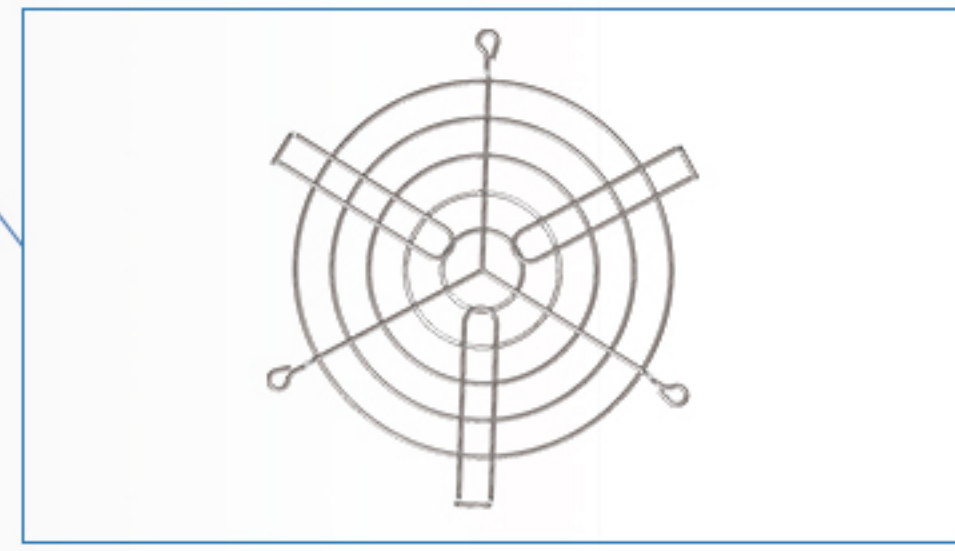

Drahtschutz
PRE-HB-highlumen-150W-COB-D

Maße (mm)

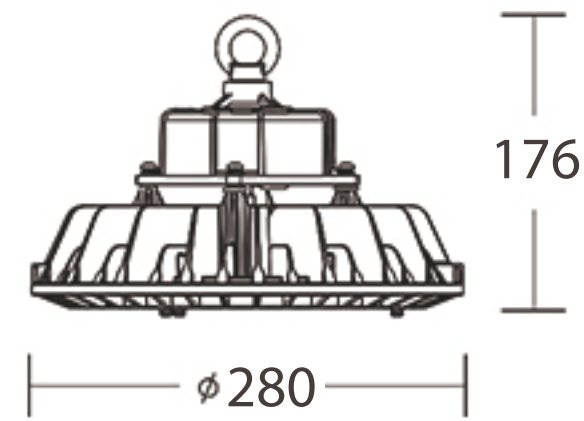

Montage

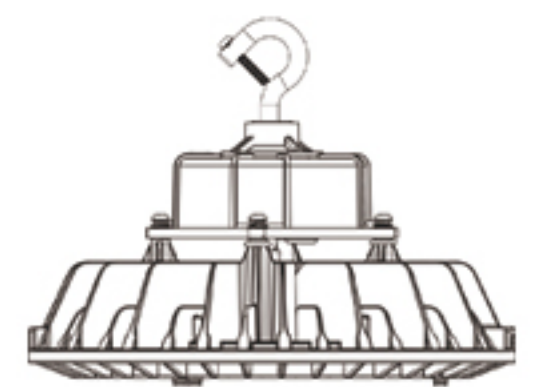
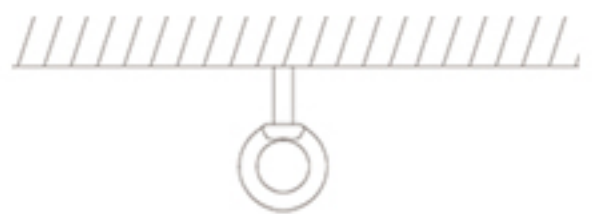

Hakenmontage

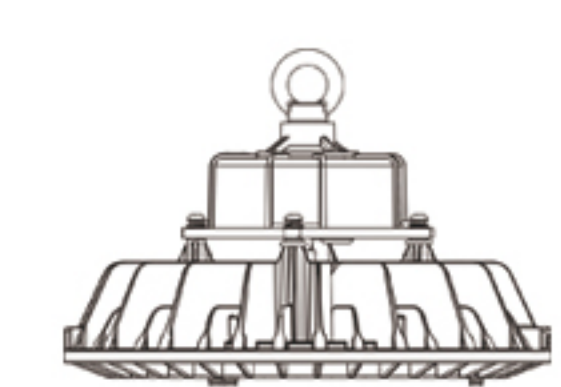

Ringhalterung

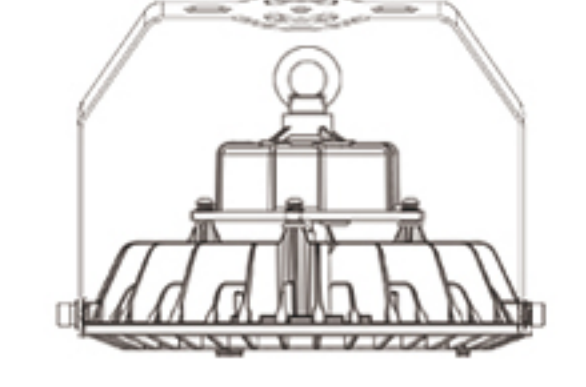
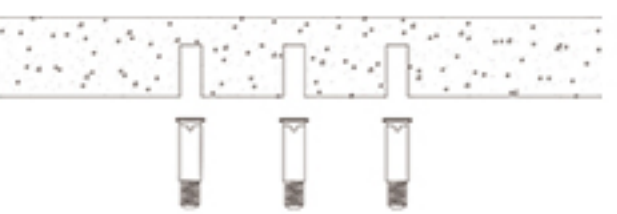

verstellbare Halterung

Zubehör

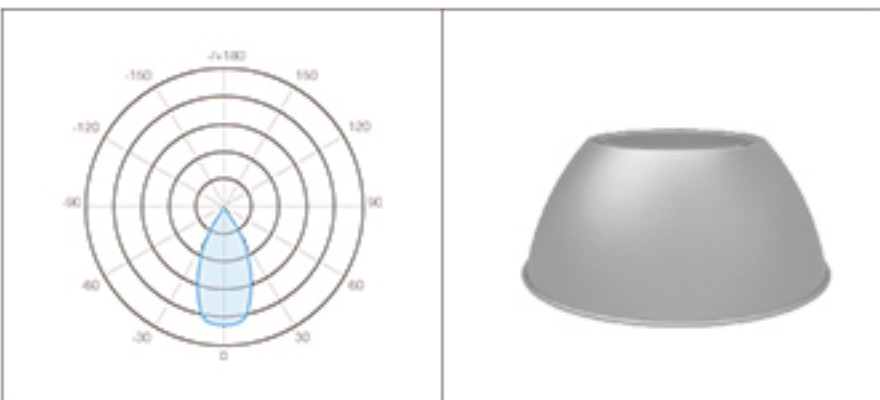

60° Aluminium Reflektor
PRE-HB-highlumen-150W-COB-60°R

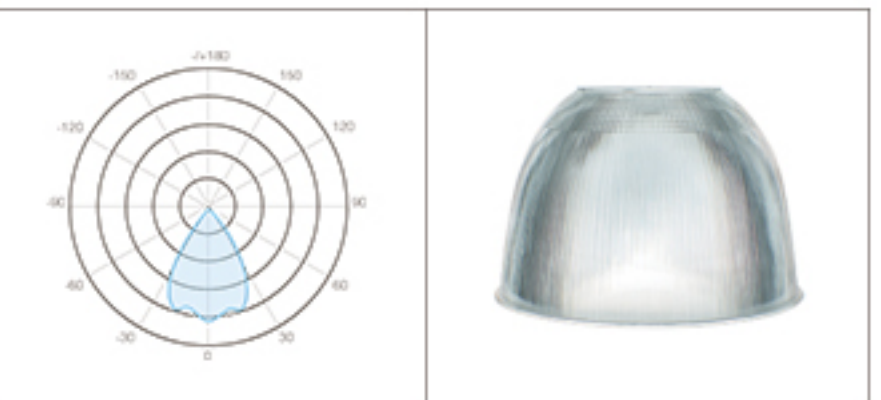

70° PC Reflektor (milchglas / transparent)
PRE-HB-highlumen-150W-COB-70°-PCM/PCT

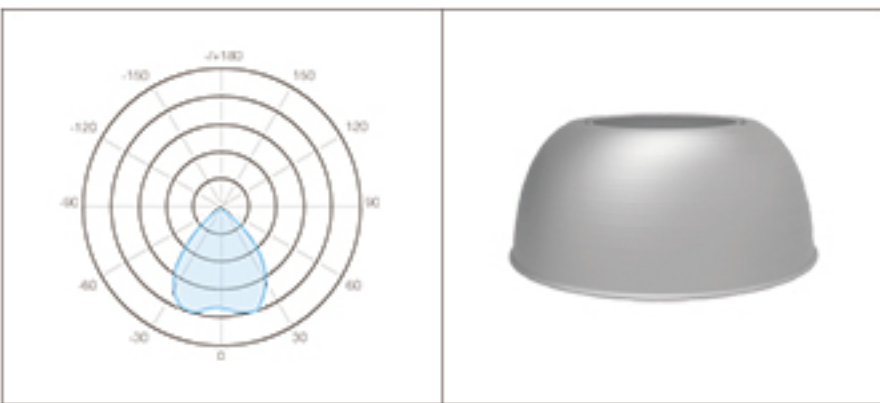

90° Aluminium Reflektor
PRE-HB-highlumen-150W-COB-90°R



120° temper Glas
PRE-HB-highlumen-150W-COB-120°-TG

STANDARD
VERSION

